

Nice



Audio System Wiring Guide for Premium 3.5" Audio System for Small Openings and SC4-100 Amplifier

Example: Small Kitchen, 2.1 System

SC-IC3 Speakers and SC-IC-SUB8 Subwoofer
Connected to SC4-100 Amplifier

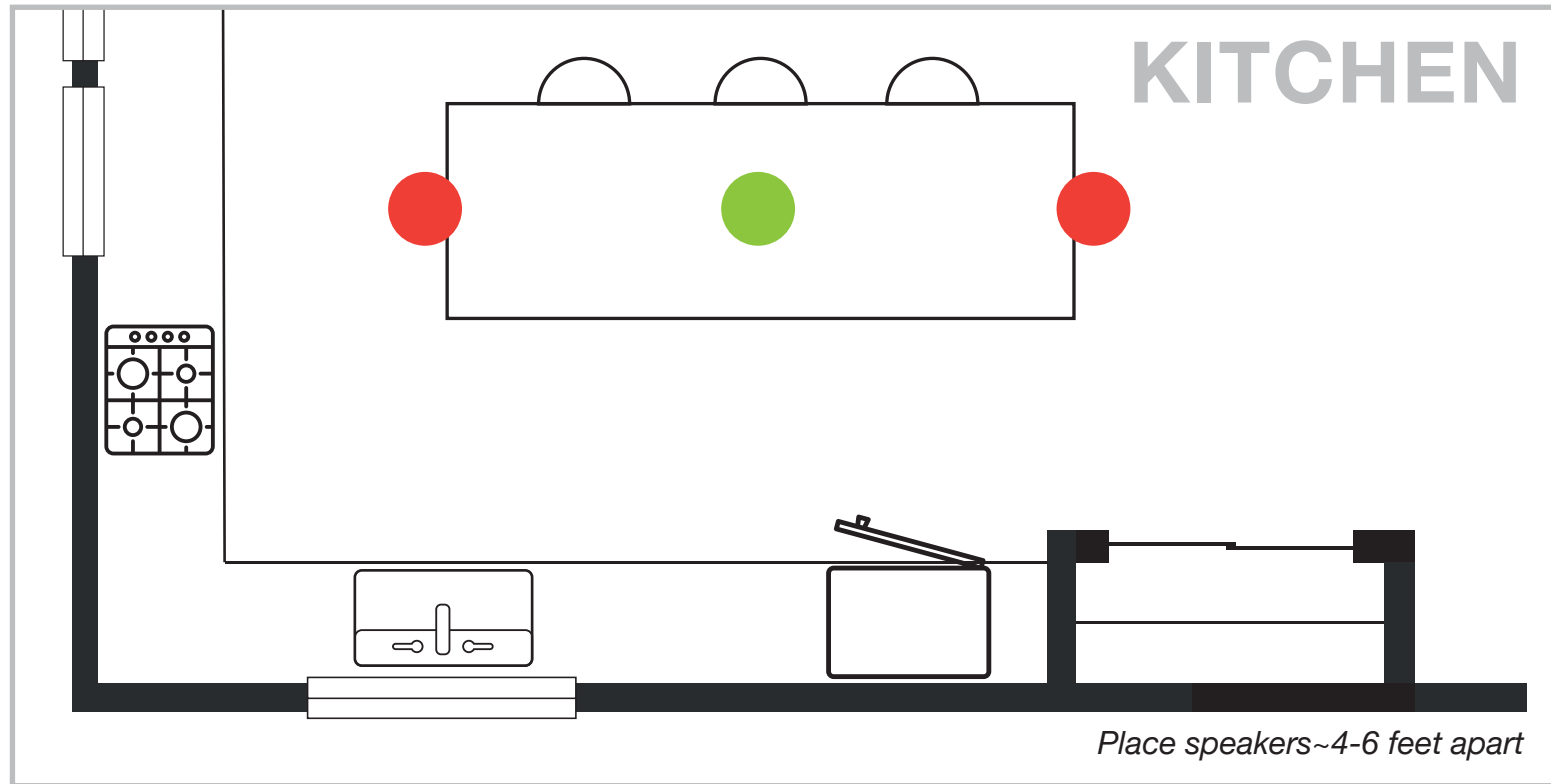

 SC-IC3 Speaker

 SC-ICSUB8 Subwoofer

2.1 Wiring to SC4-100 Amplifier

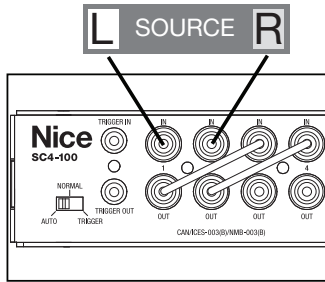

Patch 1 & 2 OUT to
3 & 4 IN

HP Filter Settings

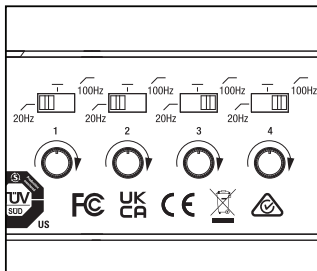

Ch 1 & 2 – Subwoofer – 20Hz
Ch 3 – Speakers – 100 Hz
Ch 4 – Speakers – 100Hz

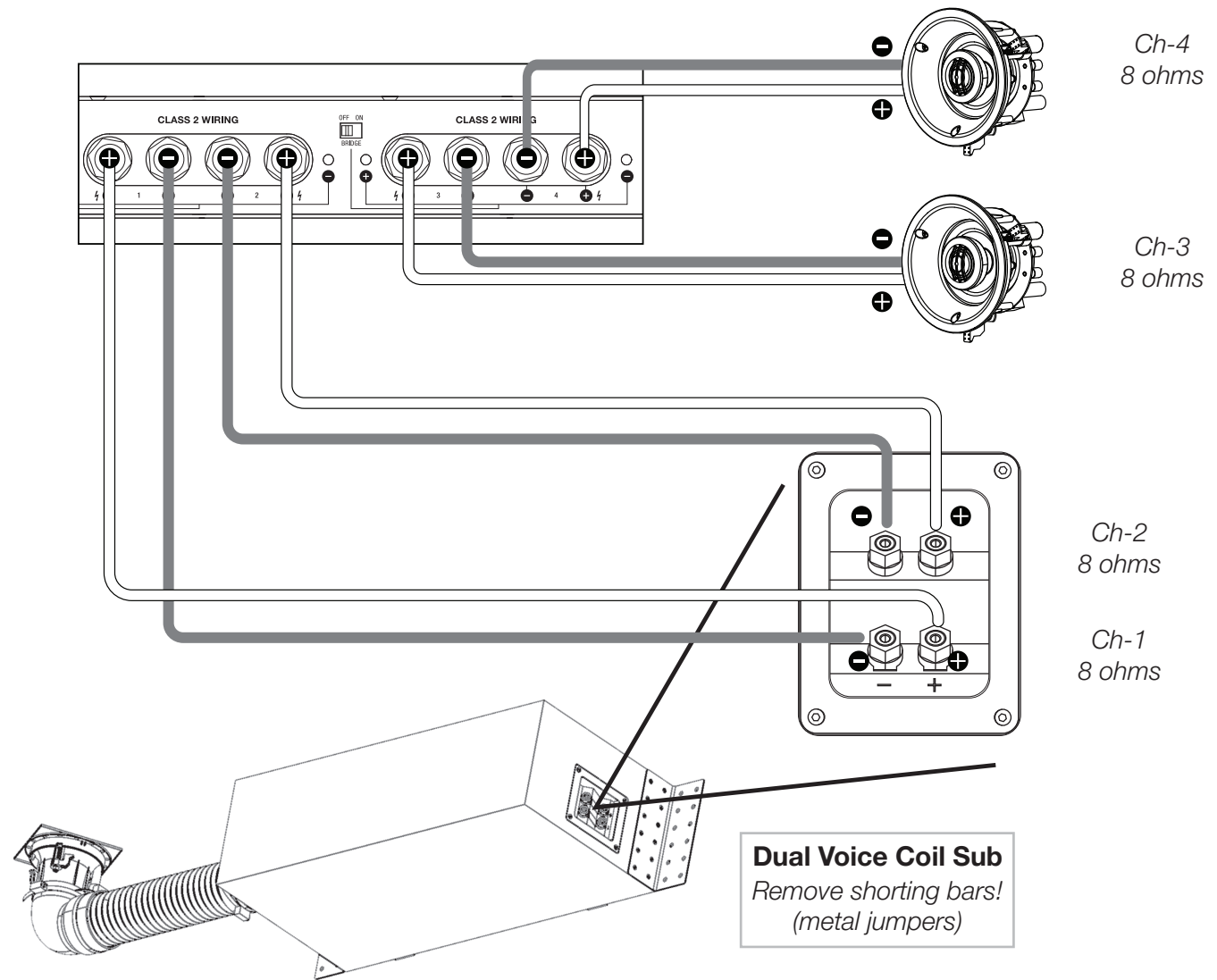

Ch-4
8 ohms

Ch-3
8 ohms

Ch-2
8 ohms

Ch-1
8 ohms

Dual Voice Coil Sub
Remove shorting bars!
(metal jumpers)

Example: Dining Room 4.1

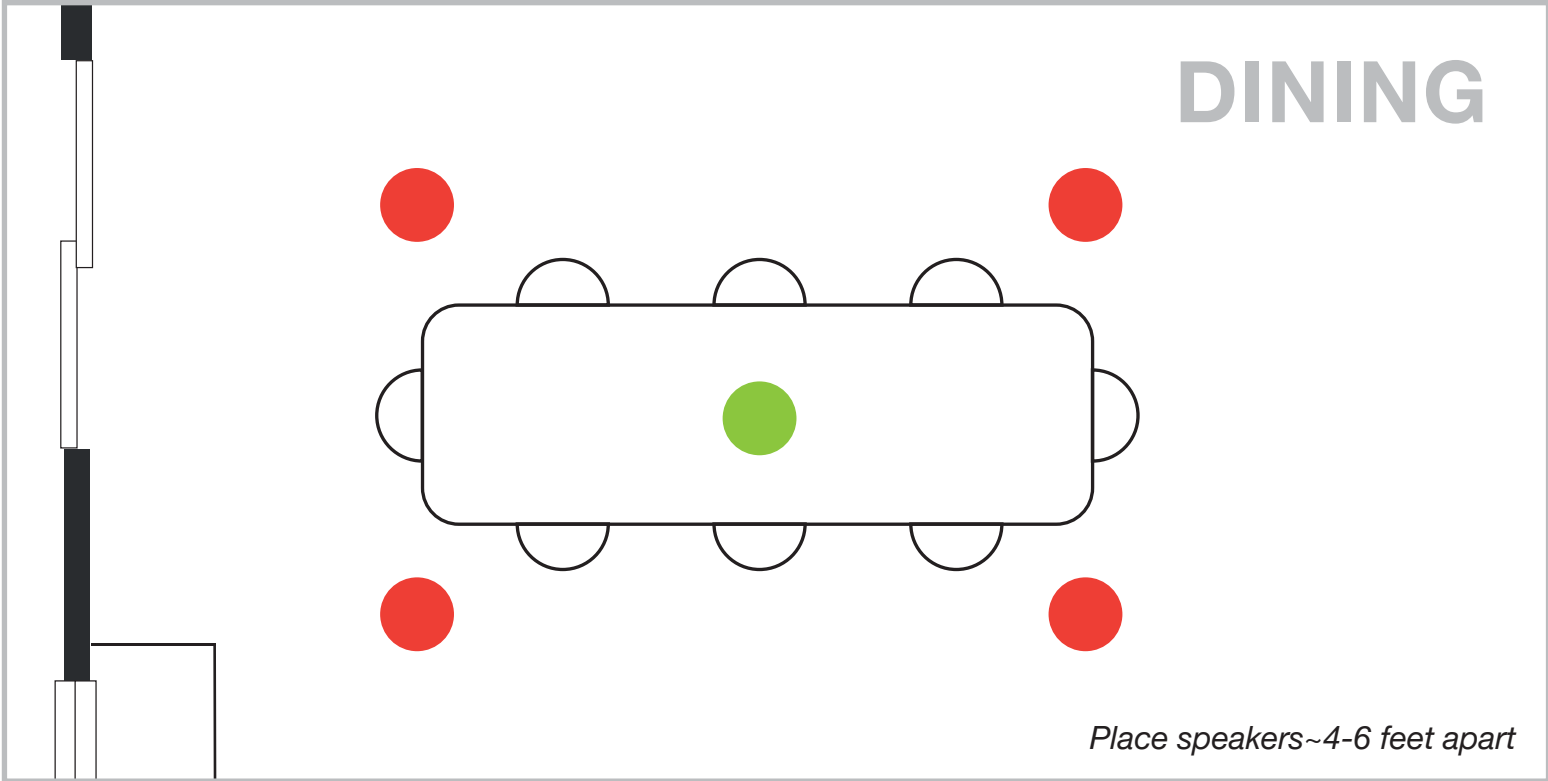

● SC-IC3 Speaker

● SC-ICSUB8 Subwoofer

4.1 Wiring to SC4-100 Amplifier

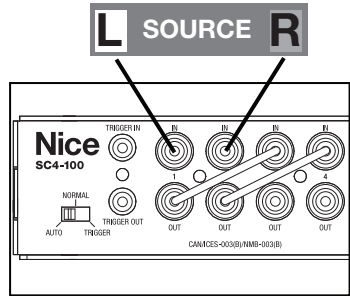

Patch 1&2 OUT to 3&4 IN

HP Filter Settings

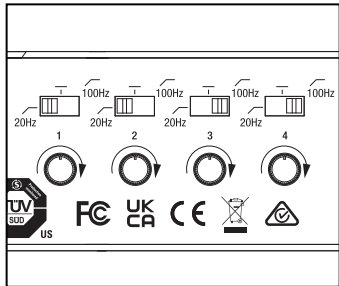

Ch 1&2 – Subwoofer – 20Hz
 Ch 3 – Speakers – 100 Hz
 Ch 4 – Speakers – 100Hz

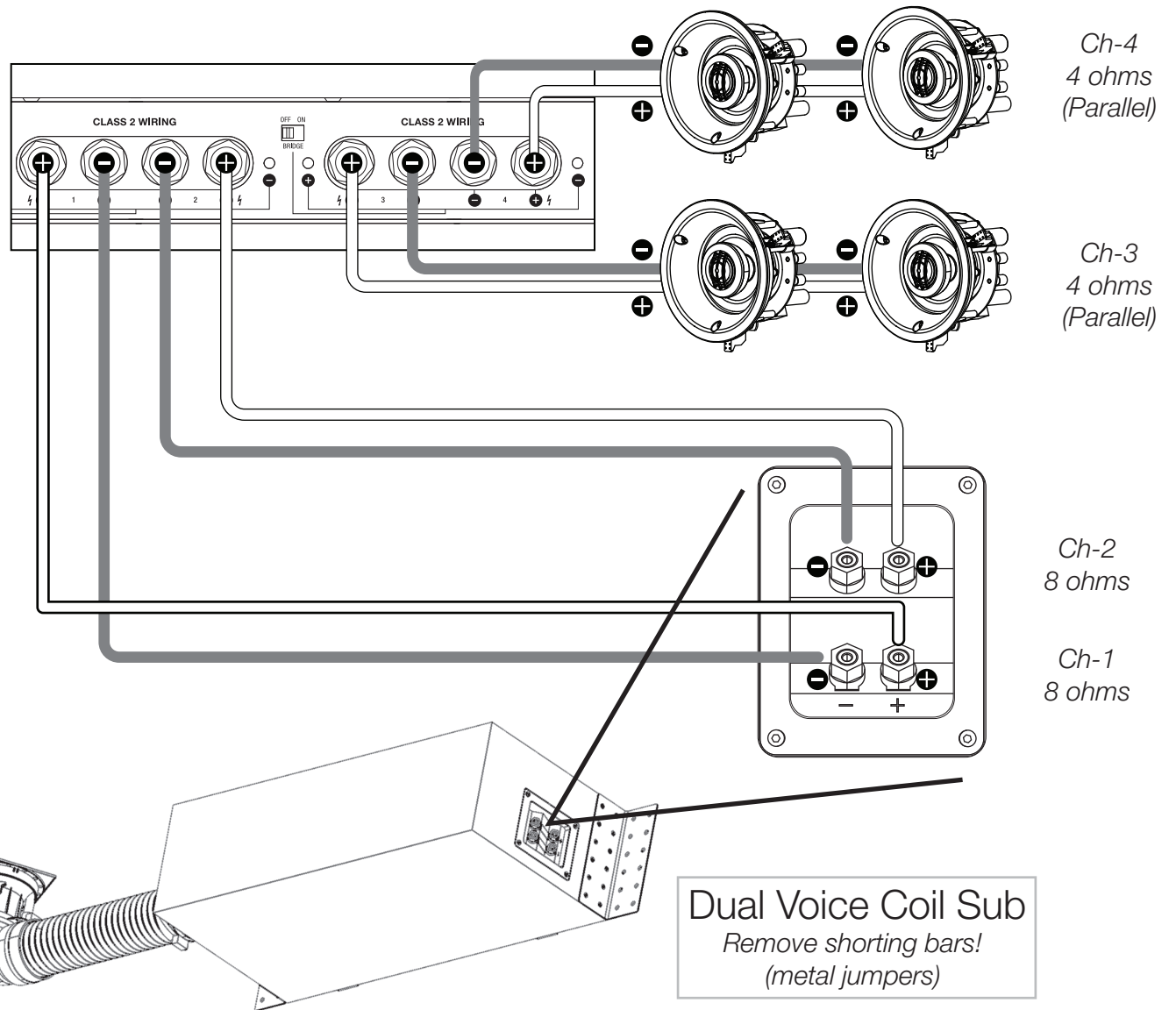

Example: Living Space 8.2

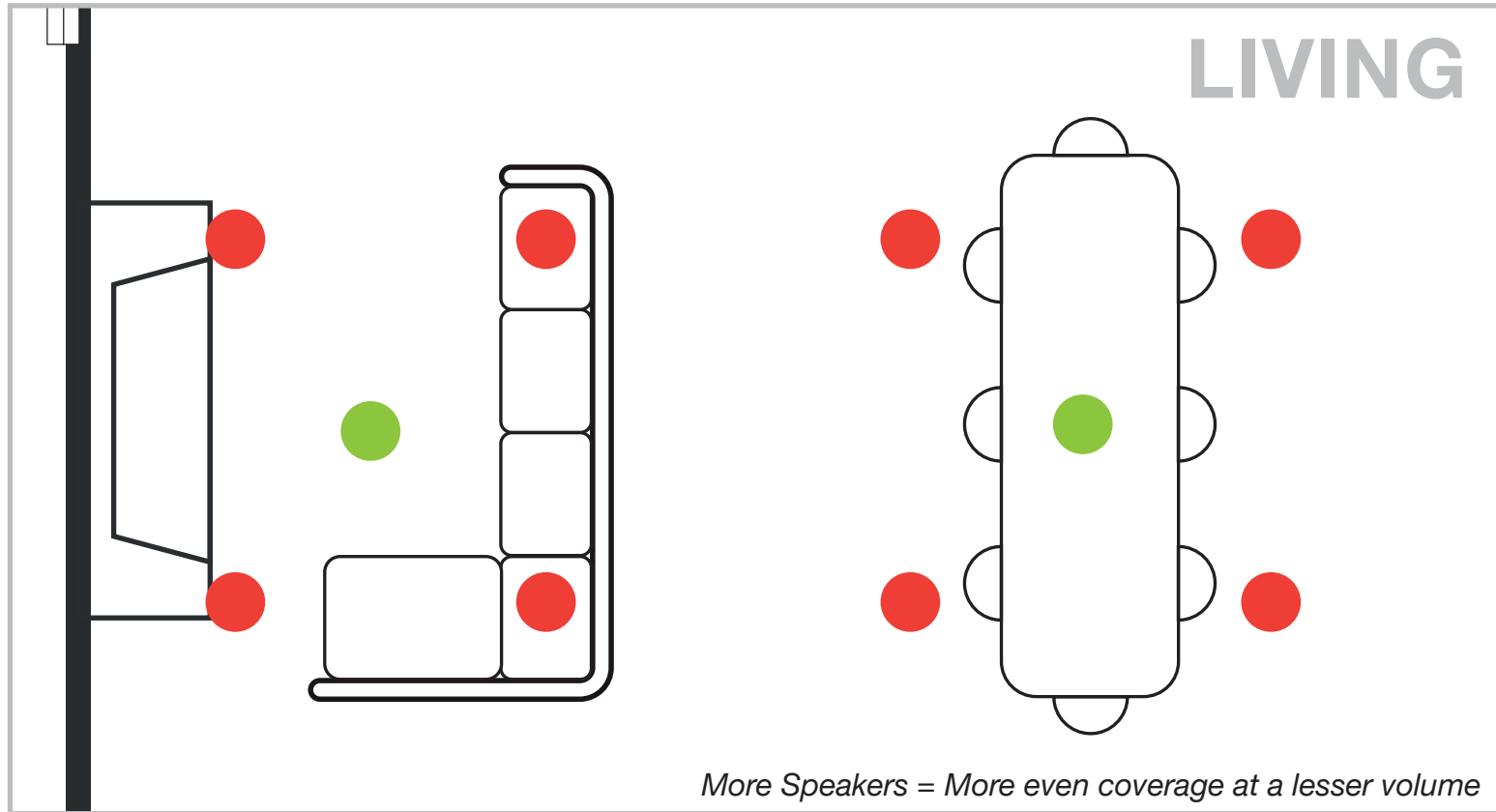

● SC-IC3 Speaker

● SC-ICSUB8 Subwoofer

8.2 Wiring two SC4-100 Amplifiers

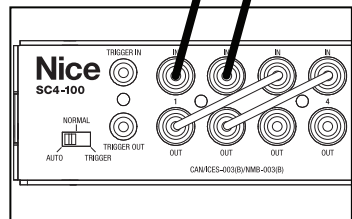
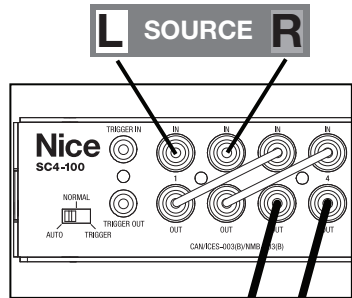

Patch 1&2 OUT to 3&4 IN
on both amps

and

Patch 3&4 OUT of first amp
to 1&2 IN of second amp

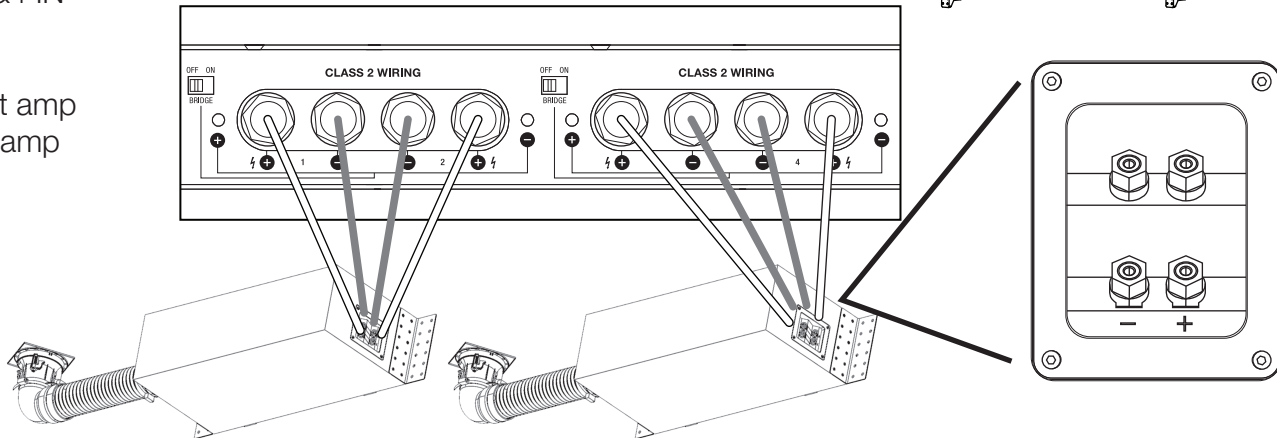
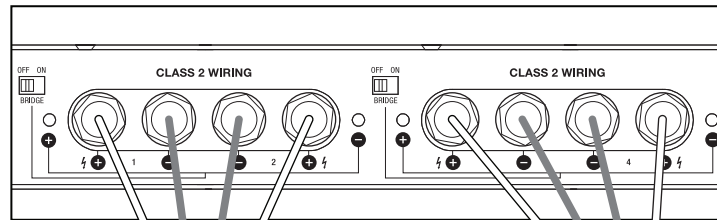
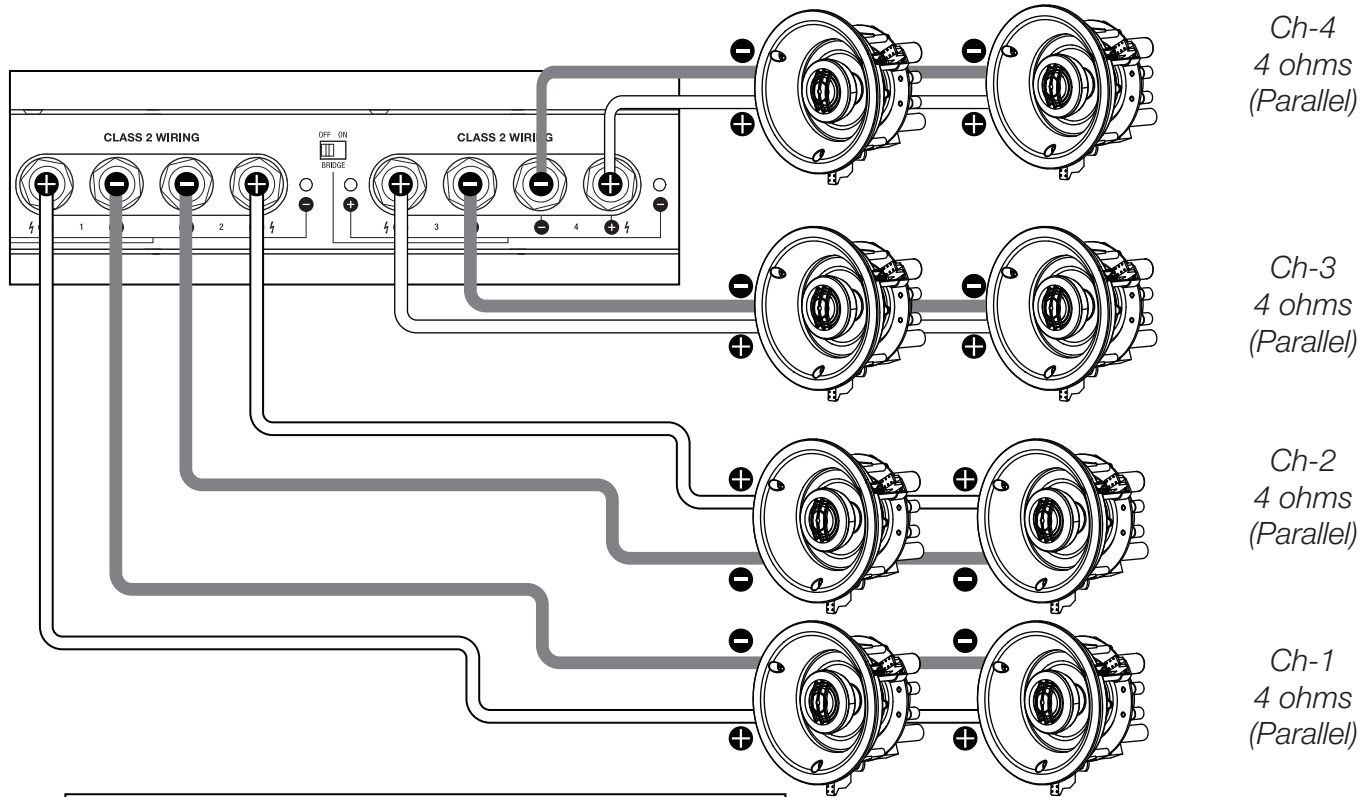

Dual Voice
Coil Subwoofers
Remove shorting bars!
(metal jumpers)

Example: Multi-Zone 12.0

(Full range speakers with EL-IPD-MTX-8CH and SC4-100)

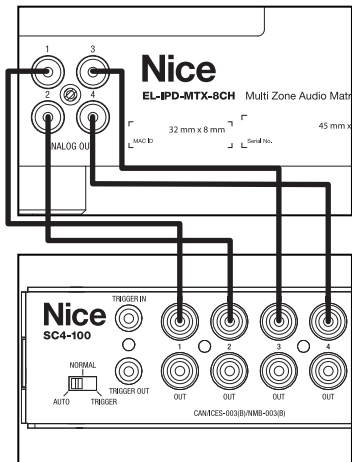

1,2,3,4 Analog OUT goes into 1,2,3,4 IN on amp

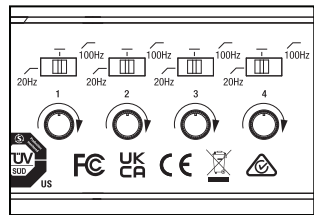

SC4 switches in flat mode

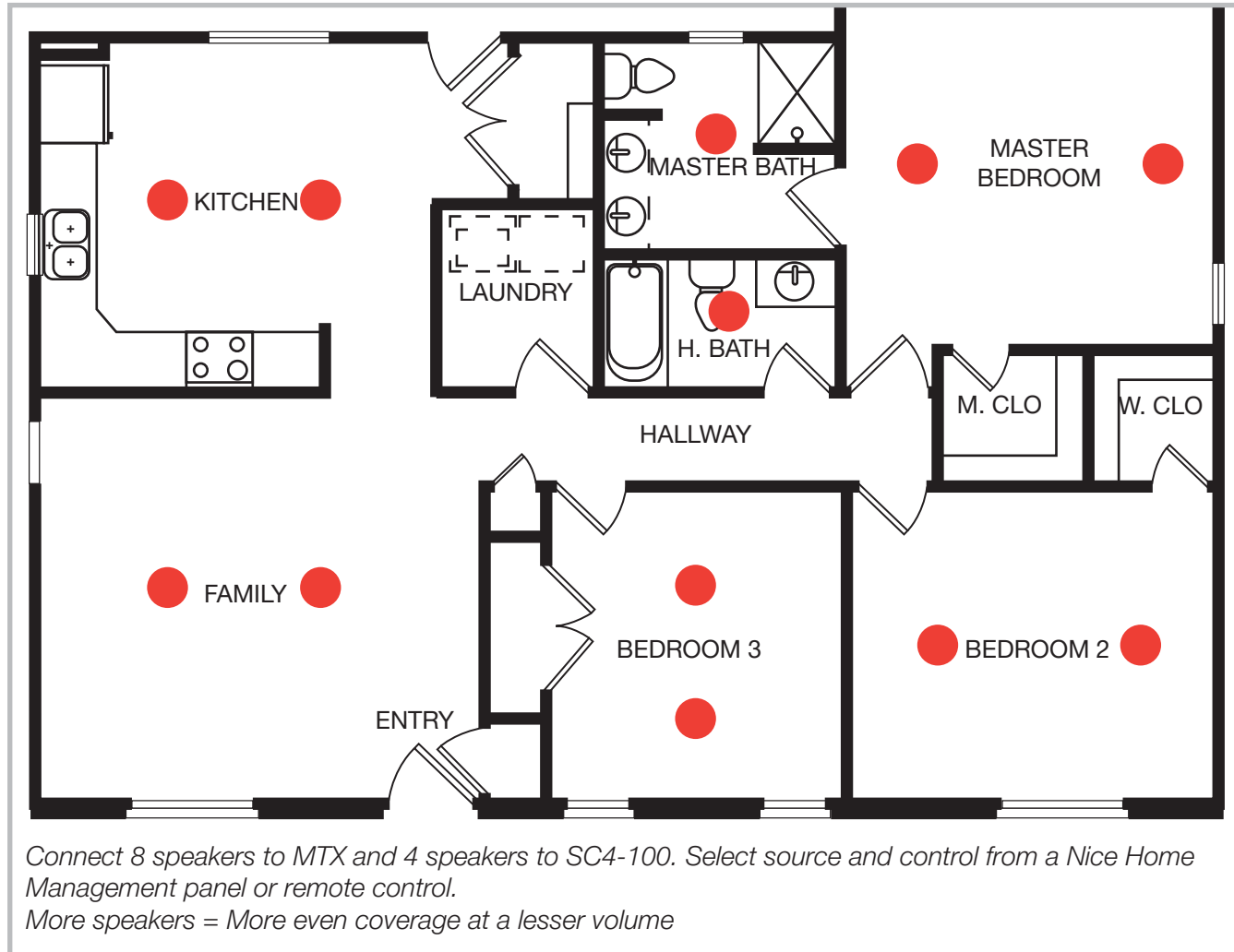

Connect 8 speakers to MTX and 4 speakers to SC4-100. Select source and control from a Nice Home Management panel or remote control.
More speakers = More even coverage at a lesser volume

 **SC-IC3 Speaker**

Wiring in Bridge Mode

Use Bridge Mode for speakers requiring higher power

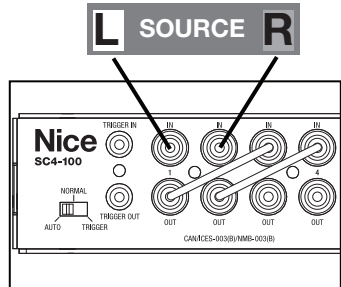

Patch 1&2 OUT to 3&4 IN

HP Filter Settings

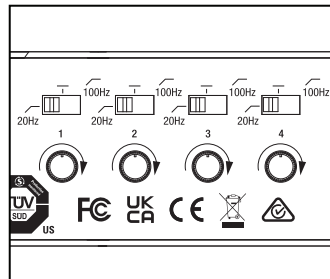

Set all to 20Hz

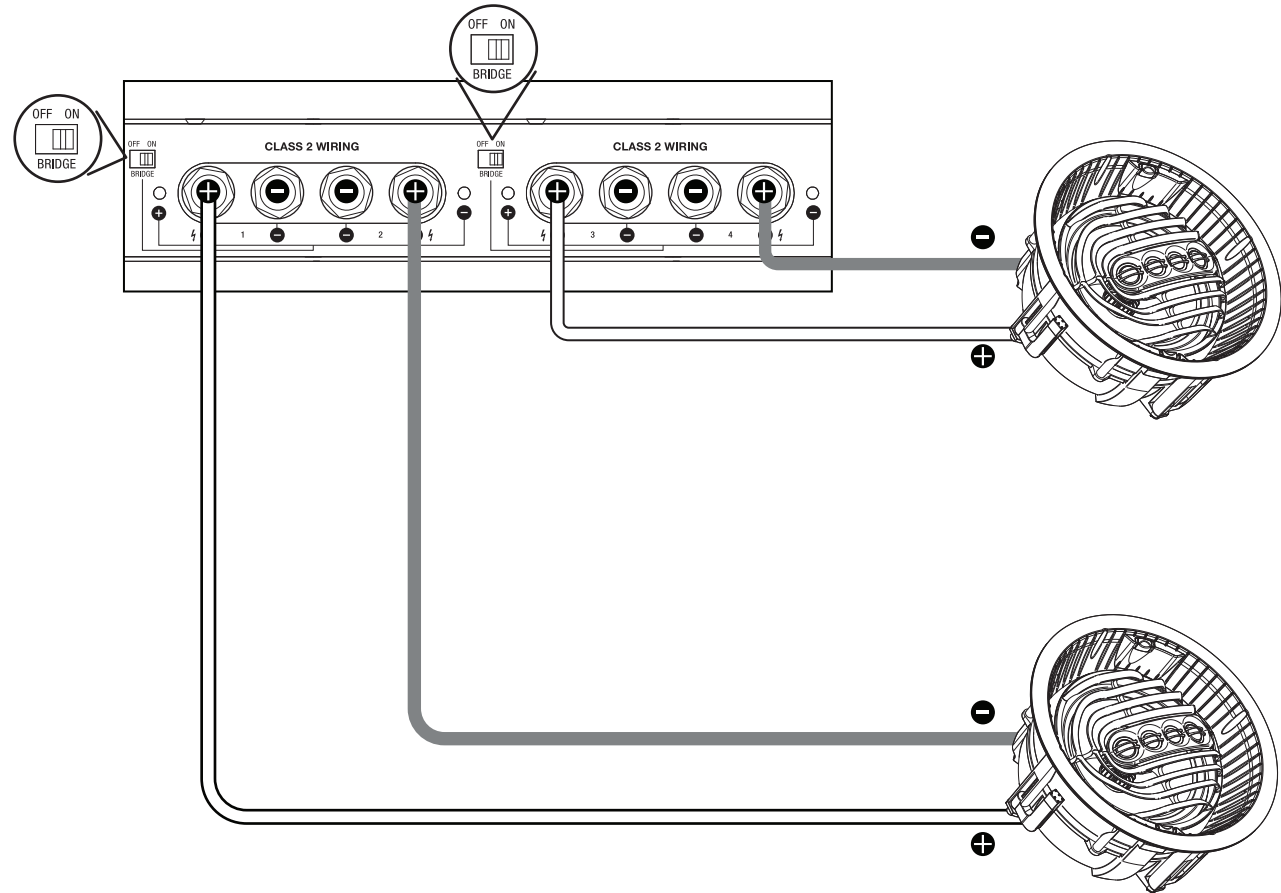

SC-IC3 Mechanical Drawing

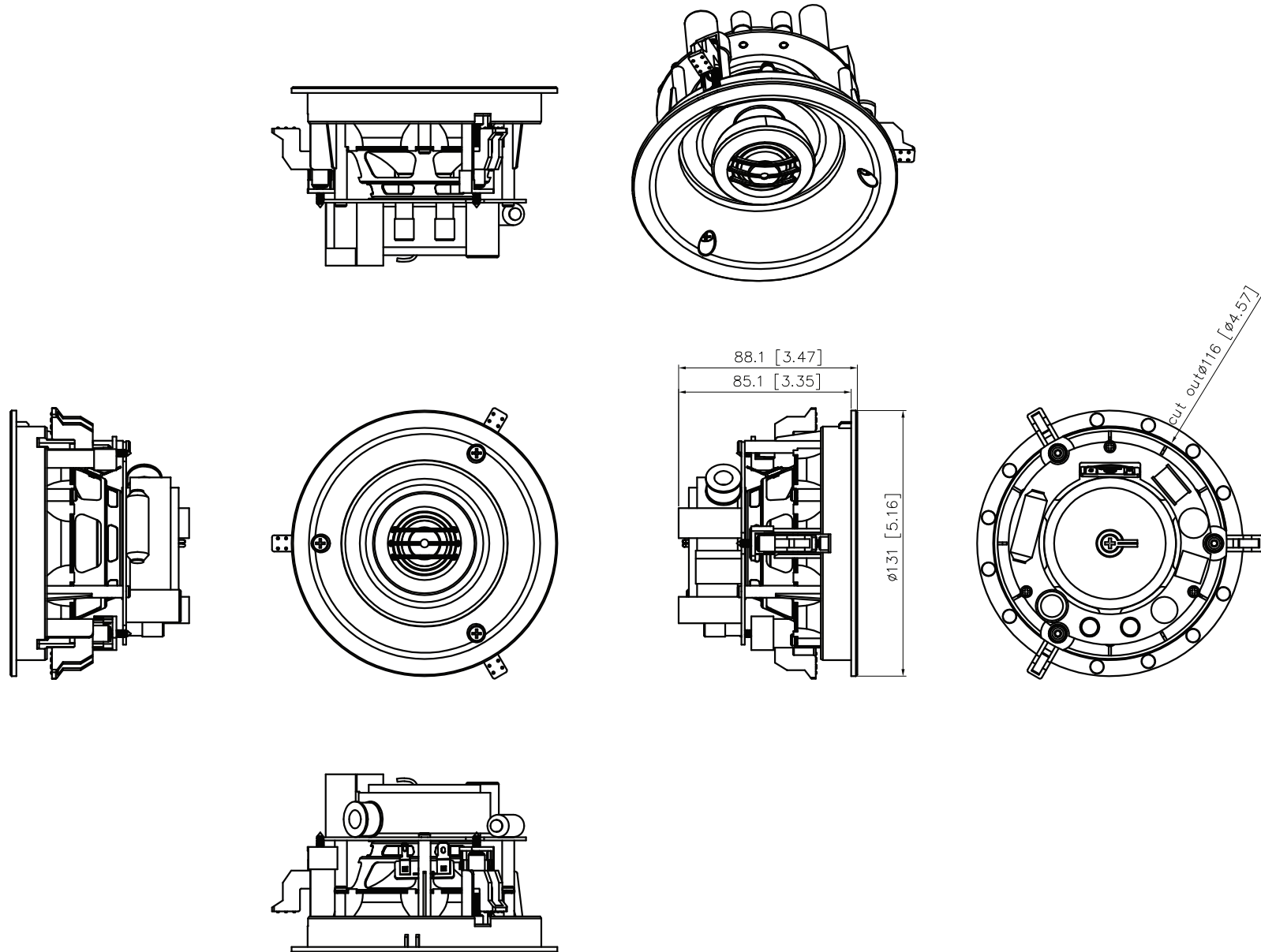

SC-IC-SUB8 Mechanical Drawing

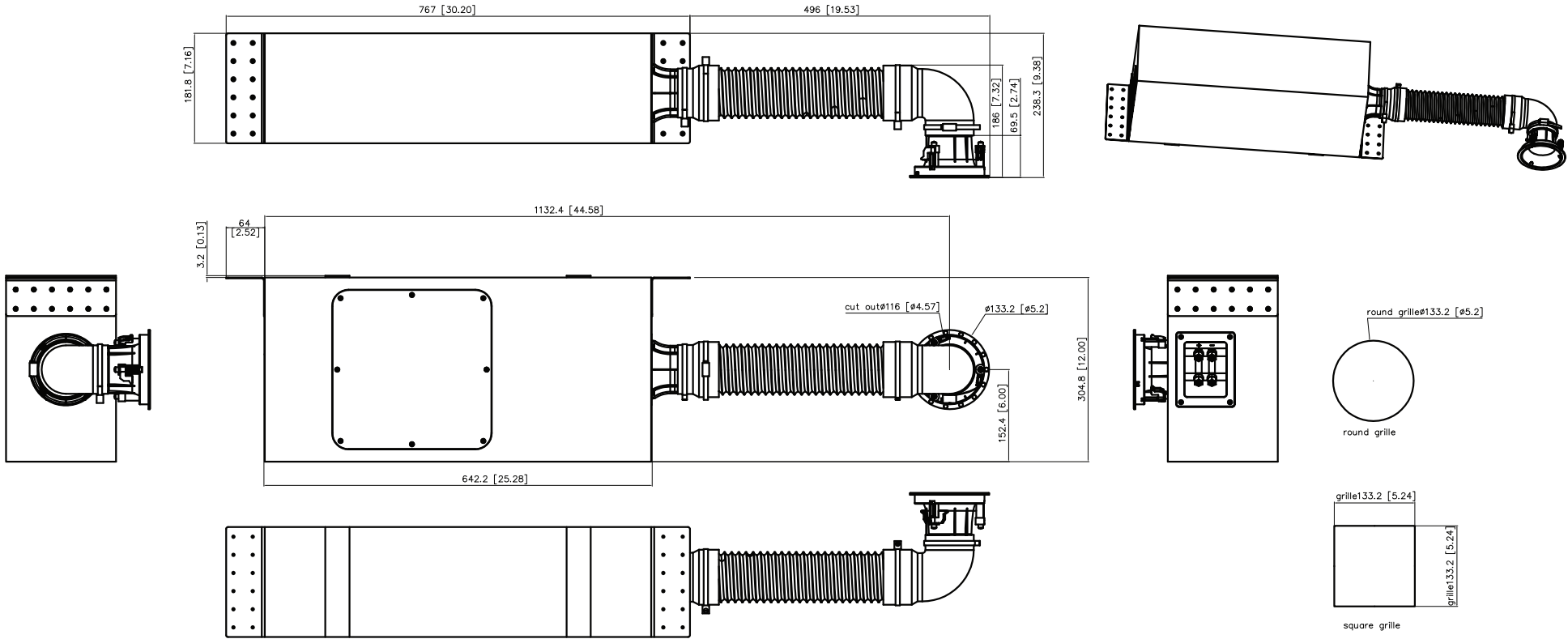

SC4-100 Mechanical Drawing

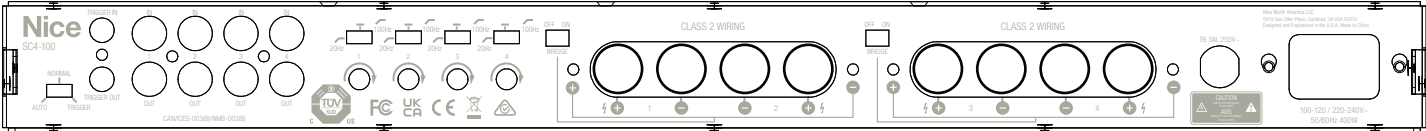
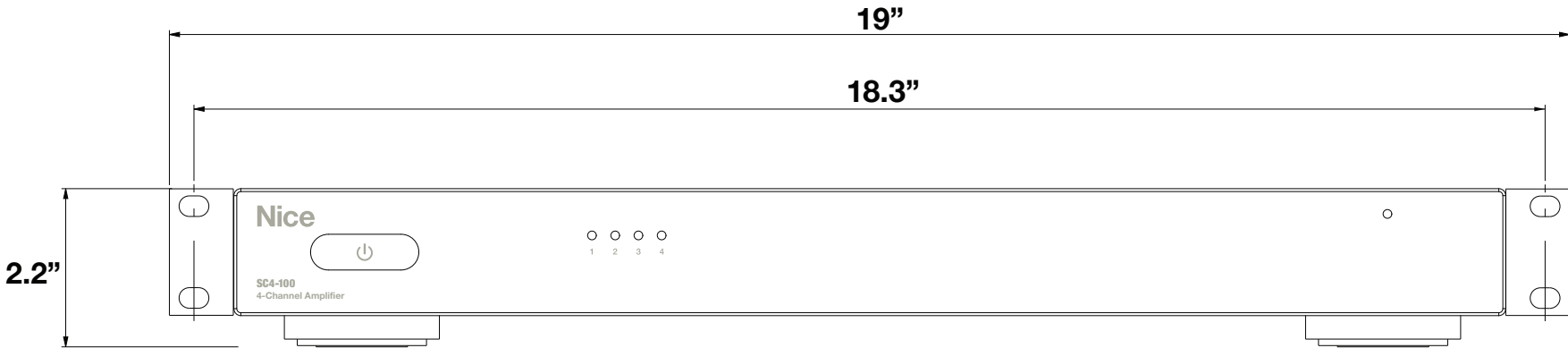
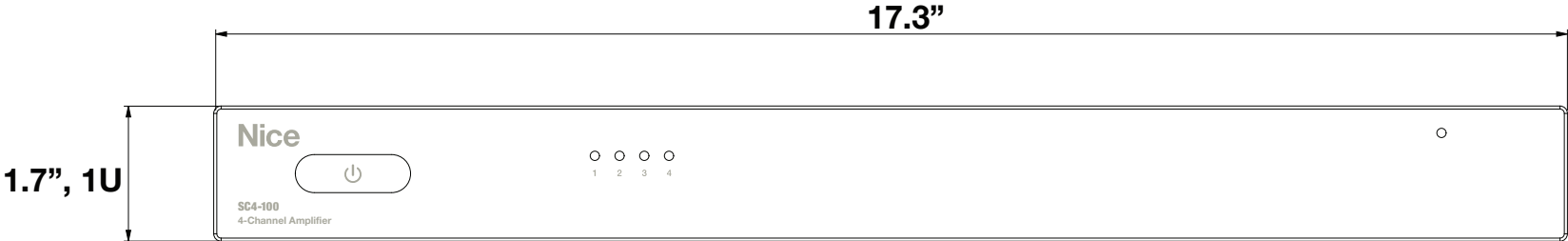

Nice Home Management Audio/Video

Built into every Nice audio product is a collective 100 years of audio technology created with unique design and non-stop innovation.

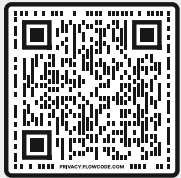

Niceforyou.com